

**LETOP**

**Modular Contactor**  
**BMC7 Series**

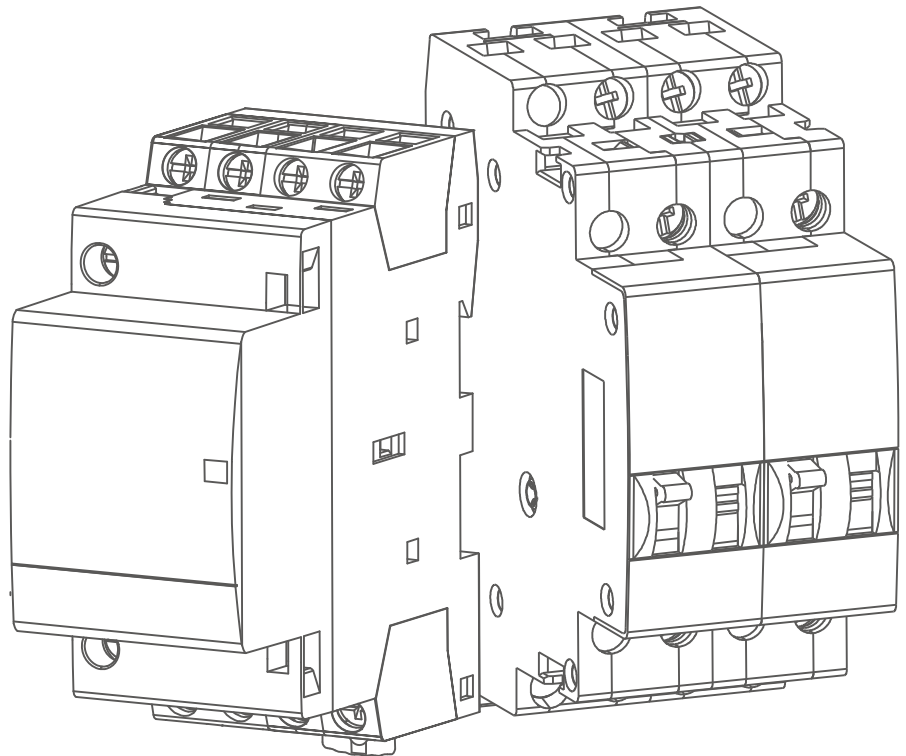

**LETOP**

**WENZHOU LETOP ELECTRIC CO.,LTD.**

## Application

BMC7 modular contactor (hereinafter referred to as contactor) is mainly suitable for AC 50Hz (or 60Hz), rated working voltage to 400V and rated current operation in the circuit up to 63A, it can control the low-inductance and low-inductance load of household appliances and similar purposes; it can also be used to control the load of household motors. The power should be reduced accordingly.

BMC7 contactors according to standard IEC/EN61095 , IEC60947-4-1 and are used mainly in buildings for switching and controlling lighting, heating, ventilation and pumps. They are part of the complete range of Din rail products and can be integrated easily in dedicated panels.

## Modular contactor

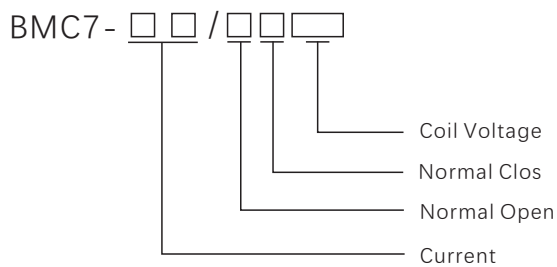

(eg. BMC7-25/20 230V . It is 25A , 2NO ,230V AC current coil voltage)



Contactor Model	Ie Rating		Uc	Circuit Diagram
	AC-7a AC-1	AC-7b AC-3		
BMC7-16/10	16A	6A	12V AC/DC 24V AC/DC 48V AC/DC 110V AC/DC 230V AC/DC	
BMC7-20/10	20A	7A		
BMC7-25/10	25A	9A		
BMC7-32/10	32A	12A		
BMC7-16/01	16A	6A	12V AC/DC 24V AC/DC 48V AC/DC 110V AC/DC 230V AC/DC	
BMC7-20/01	20A	7A		
BMC7-25/01	25A	9A		
BMC7-32/01	32A	12A		

# BMC7 Modular Contactor

**AC/DC 1P, 2modules**

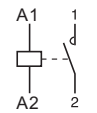
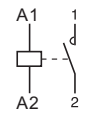
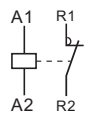
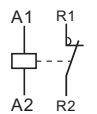

Contactor Model	Ie Rating		Uc	Circuit Diagram
	AC-7a AC-1	AC-7b AC-3		
BMC7-40/10	40A	18A	12V AC/DC 24V AC/DC 48V AC/DC 110V AC/DC 230V AC/DC	
BMC7-63/10	63A	25A	12V AC/DC 24V AC/DC 48V AC/DC 110V AC/DC 230V AC/DC	
BMC7-40/01	40A	18A	12V AC/DC 24V AC/DC 48V AC/DC 110V AC/DC 230V AC/DC	
BMC7-63/01	63A	25A	12V AC/DC 24V AC/DC 48V AC/DC 110V AC/DC 230V AC/DC	

**AC/DC 2P, 1modules**

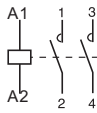
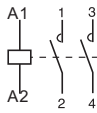
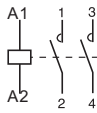
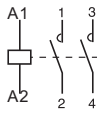
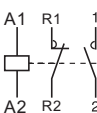
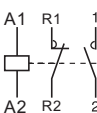
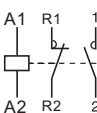
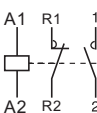
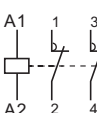
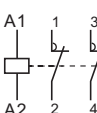
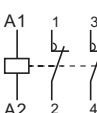
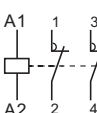

Contactor Model	Ie Rating		Uc	Circuit Diagram
	AC-7a AC-1	AC-7b AC-3		
BMC7-16/20	16A	6A	12V AC/DC 24V AC/DC 48V AC/DC 110V AC/DC 230V AC/DC	
BMC7-20/20	20A	7A	12V AC/DC 24V AC/DC 48V AC/DC 110V AC/DC 230V AC/DC	
BMC7-25/20	25A	9A	12V AC/DC 24V AC/DC 48V AC/DC 110V AC/DC 230V AC/DC	
BMC7-32/20	32A	12A	12V AC/DC 24V AC/DC 48V AC/DC 110V AC/DC 230V AC/DC	
BMC7-16/11	16A	6A	12V AC/DC 24V AC/DC 48V AC/DC 110V AC/DC 230V AC/DC	
BMC7-20/11	20A	7A	12V AC/DC 24V AC/DC 48V AC/DC 110V AC/DC 230V AC/DC	
BMC7-25/11	25A	9A	12V AC/DC 24V AC/DC 48V AC/DC 110V AC/DC 230V AC/DC	
BMC7-32/11	32A	12A	12V AC/DC 24V AC/DC 48V AC/DC 110V AC/DC 230V AC/DC	
BMC7-16/02	16A	6A	12V AC/DC 24V AC/DC 48V AC/DC 110V AC/DC 230V AC/DC	
BMC7-20/02	20A	7A	12V AC/DC 24V AC/DC 48V AC/DC 110V AC/DC 230V AC/DC	
BMC7-25/02	25A	9A	12V AC/DC 24V AC/DC 48V AC/DC 110V AC/DC 230V AC/DC	
BMC7-32/02	32A	12A	12V AC/DC 24V AC/DC 48V AC/DC 110V AC/DC 230V AC/DC	

**AC/DC 2P, 2modules**

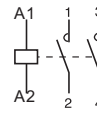
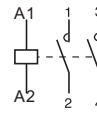
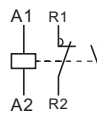
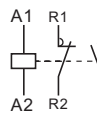
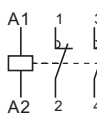
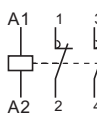

Contactor Model	Ie Rating		Uc	Circuit Diagram
	AC-7a AC-1	AC-7b AC-3		
BMC7-40/20	40A	18A	12V AC/DC 24V AC/DC 48V AC/DC 110V AC/DC 230V AC/DC	
BMC7-63/20	63A	25A	12V AC/DC 24V AC/DC 48V AC/DC 110V AC/DC 230V AC/DC	
BMC7-40/11	40A	18A	12V AC/DC 24V AC/DC 48V AC/DC 110V AC/DC 230V AC/DC	
BMC7-63/11	63A	25A	12V AC/DC 24V AC/DC 48V AC/DC 110V AC/DC 230V AC/DC	
BMC7-40/02	40A	18A	12V AC/DC 24V AC/DC 48V AC/DC 110V AC/DC 230V AC/DC	
BMC7-63/02	63A	25A	12V AC/DC 24V AC/DC 48V AC/DC 110V AC/DC 230V AC/DC	

AC/DC 3P,2modules



Contactor Model	Ie Rating		Uc	Circuit Diagram
	AC-7a AC-1	AC-7b AC-3		
BMC7-16/30	16A	6A	12V AC/DC 24V AC/DC 48V AC/DC 110V AC/DC 230V AC/DC	
BMC7-20/30	20A	7A		
BMC7-25/30	25A	9A		
BMC7-32/30	32A	12A		
BMC7-16/03	16A	6A	12V AC/DC 24V AC/DC 48V AC/DC 110V AC/DC 230V AC/DC	
BMC7-20/03	20A	7A		
BMC7-25/03	25A	9A		
BMC7-32/03	32A	12A		

AC/DC 3P,3modules



Contactor Model	Ie Rating		Uc	Circuit Diagram
	AC-7a AC-1	AC-7b AC-3		
BMC7-40/30	40A	18A	12V AC/DC 24V AC/DC 48V AC/DC 110V AC/DC 230V AC/DC	
BMC7-63/30	63A	25A		
BMC7-40/03	40A	18A		
BMC7-63/03	63A	25A		

AC/DC 4P,2modules



Contactor Model	Ie Rating		Uc	Circuit Diagram
	AC-7a AC-1	AC-7b AC-3		
BMC7-16/40	16A	6A	12V AC/DC 24V AC/DC 48V AC/DC 110V AC/DC 230V AC/DC	
BMC7-20/40	20A	7A		
BMC7-25/40	25A	9A		
BMC7-32/40	32A	12A		
BMC7-16/04	16A	6A	12V AC/DC 24V AC/DC 48V AC/DC 110V AC/DC 230V AC/DC	
BMC7-20/04	20A	7A		
BMC7-25/04	25A	9A		
BMC7-32/04	32A	12A		
BMC7-16/22	16A	6A		
BMC7-20/22	20A	7A		
BMC7-25/22	25A	9A		
BMC7-32/22	32A	12A		
BMC7-16/31	16A	6A	12V AC/DC 24V AC/DC 48V AC/DC 110V AC/DC 230V AC/DC	
BMC7-20/31	20A	7A		
BMC7-25/31	25A	9A		
BMC7-32/31	32A	12A		

AC/DC 4P,3modules



Contactor Model	Ie Rating		Uc	Circuit Diagram
	AC-7a AC-1	AC-7b AC-3		
BMC7-40/40	40A	18A	12V AC/DC 24V AC/DC 48V AC/DC 110V AC/DC 230V AC/DC	
BMC7-63/40	63A	25A	12V AC/DC 24V AC/DC 48V AC/DC 110V AC/DC 230V AC/DC	
BMC7-40/04	40A	18A	12V AC/DC 24V AC/DC 48V AC/DC 110V AC/DC 230V AC/DC	
BMC7-63/04	63A	25A	12V AC/DC 24V AC/DC 48V AC/DC 110V AC/DC 230V AC/DC	
BMC7-40/22	40A	18A	12V AC/DC 24V AC/DC 48V AC/DC 110V AC/DC 230V AC/DC	
BMC7-63/22	63A	25A	12V AC/DC 24V AC/DC 48V AC/DC 110V AC/DC 230V AC/DC	
BMC7-40/31	40A	18A	12V AC/DC 24V AC/DC 48V AC/DC 110V AC/DC 230V AC/DC	
BMC7-63/31	63A	25A	12V AC/DC 24V AC/DC 48V AC/DC 110V AC/DC 230V AC/DC	

AC/DC Modular contactor power consumption

Poles	Ie Rating		Uc (VAC)(50Hz)	Power consumption		Max Power
	AC-7a	AC-7b		Hold on	Pull in	
2P	16A	6A	230	2.1VA	2.1VA	2.0W
	20A	7A	230	2.1VA	2.1VA	2.0W
	25A	9A	230	2.1VA	2.1VA	2.0W
	32A	12A	230	2.1VA	2.1VA	2.0W
	40A	18A	230	2.3VA	2.3VA	2.0W
	63A	25A	230	2.3VA	2.3VA	2.0W
4P	16A	6A	230	2.3VA	2.3VA	2.0W
	20A	7A	230	2.3VA	2.3VA	2.0W
	25A	9A	230	2.3VA	2.3VA	2.0W
	32A	12A	230	2.3VA	2.3VA	2.0W
	40A	18A	230	6.0VA	6.0VA	5.5W
	63A	25A	230	6.0VA	6.0VA	5.5W

## Modular contactor auxiliary

### Auxiliary Contacts

The Auxiliary contacts are indicator contactor contacts status switch OFF or ON

	AC-12		AC-15		DC-13		Rated Current	Circuit Diagram
	C.V.	C.A.	C.V.	C.A.	C.V.	C.A.		
BMC7-AUC11	240V	5A	230V	2A	DC 130V	1A	5A	
BMC7-AUC20	240V	5A	230V	2A	DC 130V	1A	5A	



### Spacing piece

Spacers are used to reduce the temperature rise of devices mounted side by side. It is recommended to separate electronic equipment (temperature adjustment devices, programmable timer etc.) from electromechanical equipment (impulse relays, contactors)

	Technical specifications
Spacing piece	3mm Spacing piece 9mm Spacing piece

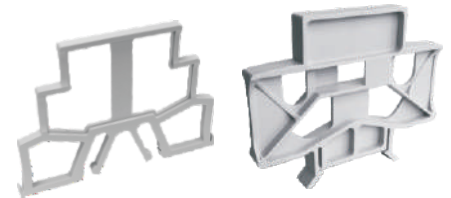

## Main parameter and technical performance

Power circuit		
Voltage rating(Ue)	1P,2P	250V AC
	3P,4P	400V AC
Frequency		50/60Hz
Endurance(O-C)		1,000,000 cycles
Electrical		100,000 cycles
Maximum number of switching operation a day		100
Insulation voltage(Ui)		500 V AC
Pollution degree		2
Rated impulse withstand voltage(Uimp)		2.5kV(4kV for 12/24/48VAC)
Degree of protection (IEC 60529)	Device only	IP20
	Device in modular enclosure	IP40
Operating temperature		-5°C~+60°C
Storage temperature		-40°C~+70°C
Tropicalization(IEC 60068.1)		Treatment 2 (relative humidity 95% at 55°C)

ELSV compliance(Extra Low Safety Voltage)for 12/24/48vac versions

The product control conforms to the SELV(safety extra low voltage)requirements

(1)In the case of contactor mounting in a enclosure for which the interior temperature is in range between 50 °C and 60 °C,it is necessary to use a spacer, between each contactor



Clip on DIN rail 35 mm

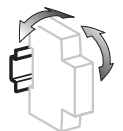

±30°vertical.

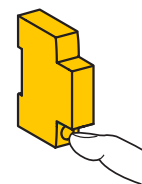

IP20



IP40

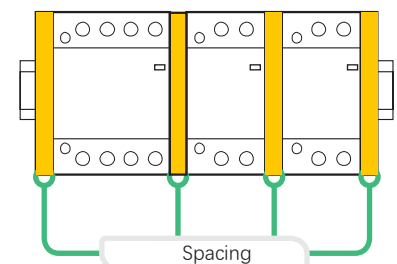

## Packing information

Poles	Rated Current (A)	BOX QTY	CTN QTY	Automatic Contactor		Manual Contactor		CARTON SIZE (mm)
				G.W.(kg)	N.W.(kg)	G.W.(kg)	N.W.(kg)	
2P	16	12	120	16.3	14.1	16.3	14.1	500×260×190
	20	12	120	16.3	14.1	16.3	14.1	500×260×190
	25	12	120	16.3	14.1	16.3	14.1	500×260×190
	32	12	120	16.3	14.1	16.3	14.1	500×260×190
	40	6	60	15.7	13.9	15.7	13.9	500×260×190
	63	6	60	15.7	13.9	15.7	13.9	500×260×190
4P	16	6	60	14.2	12.3	13.9	12.3	500×260×190
	20	6	60	14.2	12.3	13.9	12.3	500×260×190
	25	6	60	14.2	12.3	13.9	12.3	500×260×190
	32	6	60	14.2	12.3	13.9	12.3	500×260×190
	40	4	40	15.0	13.3	15.0	13.3	500×260×190
	63	4	40	15.0	13.3	15.0	13.3	500×260×190

Type	Box Qty	CTN Qty	G.W.(kg)	N.W.(kg)	Carton Size (mm)
Auxiliary Contacts	12	120	5.56	3.96	500×260×190
3mm Spacing piece	72	720	5.56	3.36	500×260×190
9mm spacing piece	24	360	6.38	5.18	455×230×240

## Connection parameter

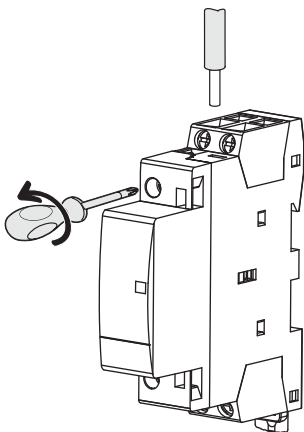

Type	Rating	Lenght tripping	Circuit	Tightening torque	Copper cables	
					Rigid	Flexible or ferrule
BMC7	16-63A	9mm	Control	0.8N.m	1.5~2.5mm <sup>2</sup> 2×1.5mm <sup>2</sup>	1.5~2.5mm <sup>2</sup> 2×2.5mm <sup>2</sup>
	16-32A		Power		1.5~6mm <sup>2</sup>	1~4mm <sup>2</sup>
BACTs	40A-63A	14mm	-	3.5N.m	6~25mm <sup>2</sup>	6~16mm <sup>2</sup>
					1.5~2.5mm <sup>2</sup> 2×1.5mm <sup>2</sup>	1.5~2.5mm <sup>2</sup> 2×2.5mm <sup>2</sup>

## Product dimensions ( mm )

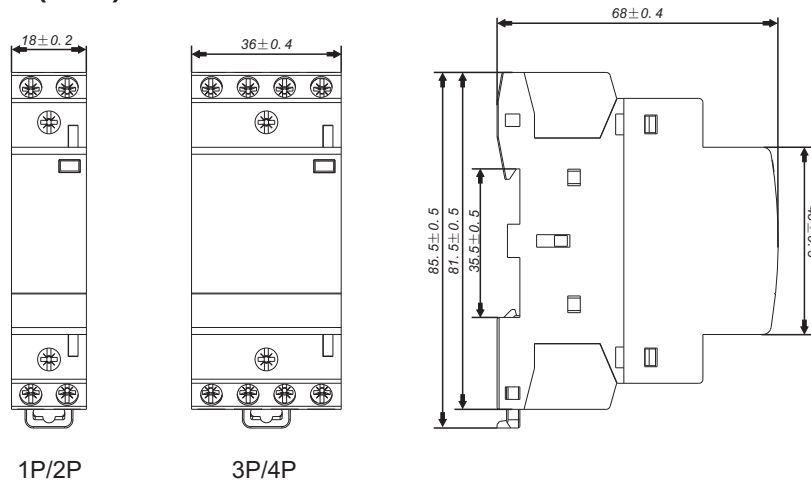

BMC7-16/20/25/32

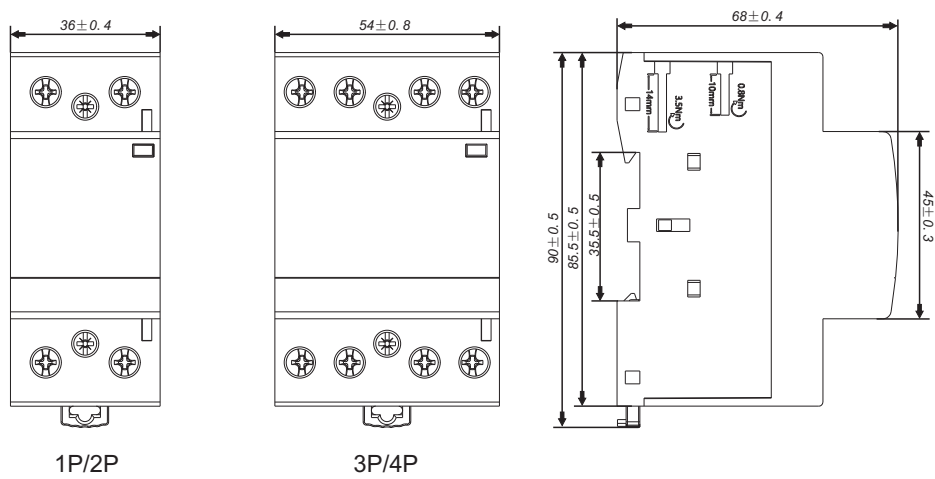

BMC7-40/63

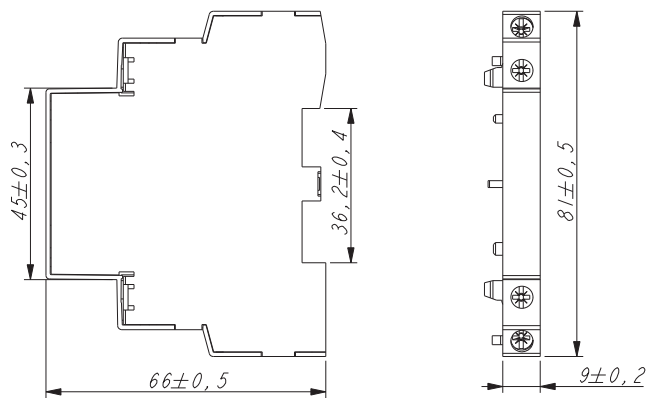

BMC7-AUC





---

WENZHOU LEDING ELECTRIC CO.,LTD.

ADD. No.19 Fenjin Road, Dongfeng Industrial Zone, Wenzhou, China 325604

E-mail: [info@letopv.com](mailto:info@letopv.com)

Website: [www.letopv.com](http://www.letopv.com)